



RECHARGEABLE LITHIUM-ION BATTERY CELL GENERAL SPECIFICATIONS

CHANGDE YIKLIK ENERGY LIMITED

Tel: (86) 736-433 8338

Fax: (86) 736-433 8333

Battery Cell Model: INR16320A70

1. Specifications

| | | |
|------|---------------------------|--------------|
| 1.1 | Nominal Capacity | 700 mAh |
| 1.2 | Minimum Capacity | 650 mAh |
| 1.3 | Nominal Voltage | 3.6 V |
| 1.4 | Internal Impedance | ≤ 85 mΩ |
| 1.5 | Energy | ≤ 2.52 Wh |
| 1.6 | Standard Charging | 140 mA |
| 1.7 | Quick Charging | 700 mA (1 C) |
| 1.8 | Charging Voltage | 4.2 V |
| 1.9 | Continuous Discharging | 2 A |
| 1.10 | Discharge Cut-off Voltage | 2.75 V |
| 1.11 | Battery Cell Weight | ≤ 21 g |

2. Product Drawing

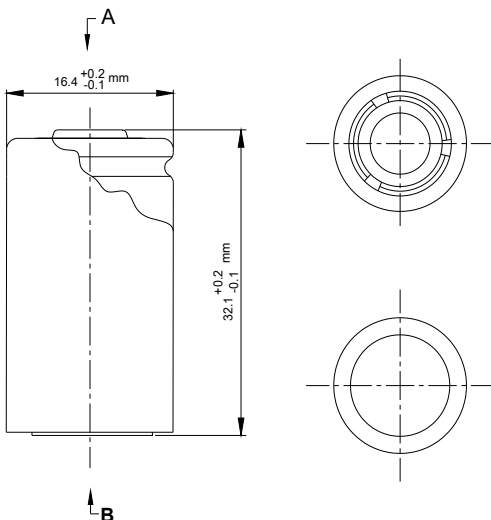

3. Characteristics: Charging

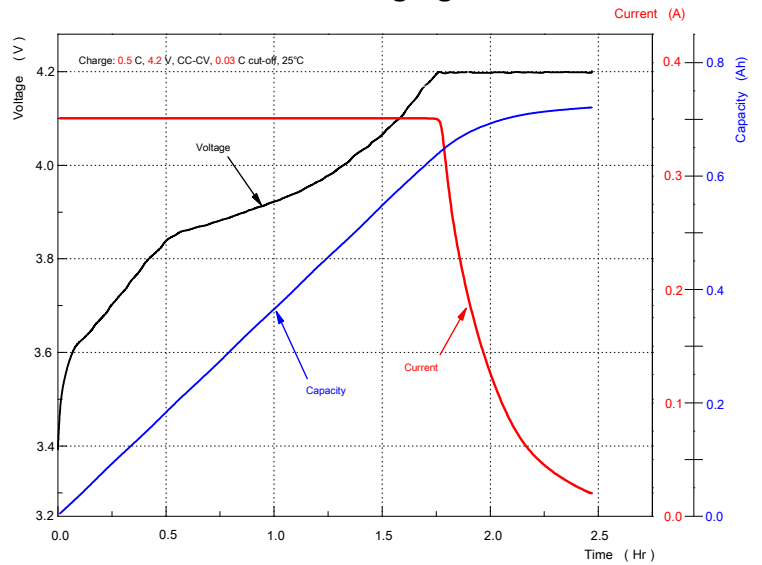

4. Characteristics: Different Discharge Rates

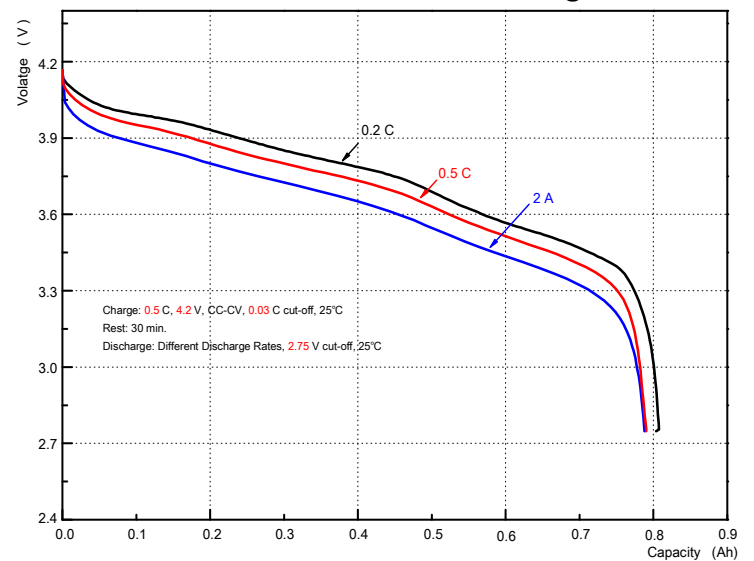

5. Characteristics: Cycle Life

